

FD 44-10 DI CR Double Convolution Air Actuator

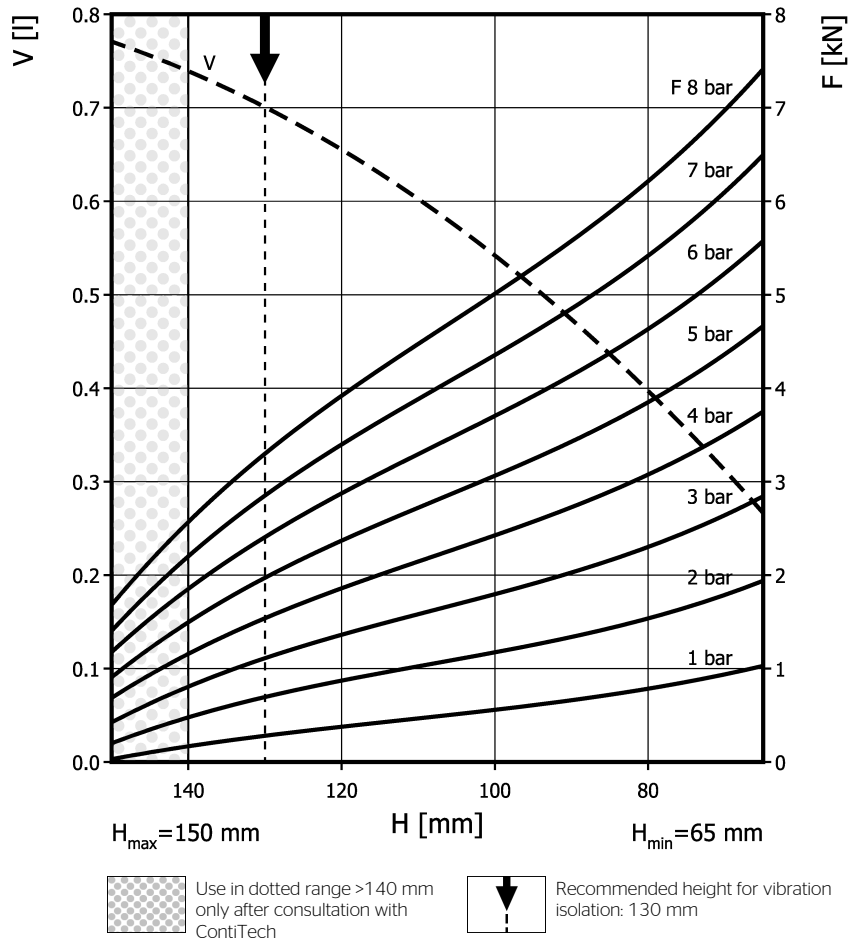
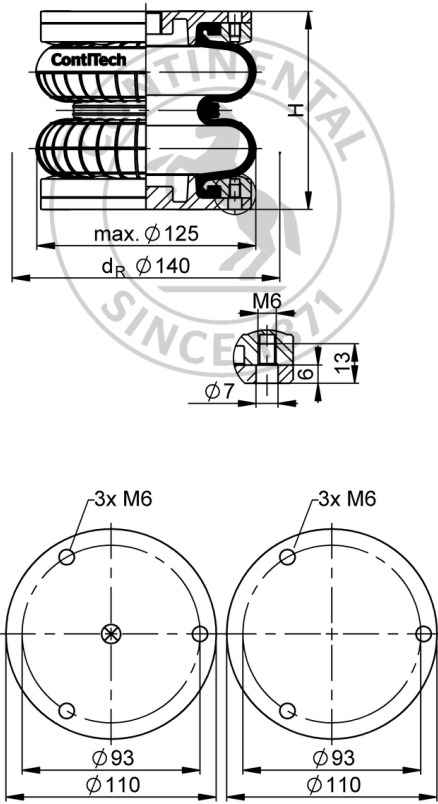

Purchase order data

Type	Order No.
rubber bellows only	79424
CR-Rubber bellows, with dismountable aluminium plates, G3/8 air inlet	70206

Additional types on request

Technical data

Min. pressure	0 bar
Return force to min height	≤ 150 N
Overall weight	0.98 kg

Vibration isolation - dynamic characteristic values

Design height H : recommended 130mm, minimum 110mm

Pressure p [bar]	3	4	5	6	7	8	Vol. V [l]
Force (Load) [kN]	1.1	1.5	2	2.4	2.8	3.2	
Spring rate [N/mm]	44	56	68	80.5	92.5	104	
Natural frequency [Hz]	3.2	3.0	3.0	2.9	2.9	2.8	

Pneumatic application - static characteristic values

Force F [kN]

Pressure p [bar]	3	4	5	6	7	8	Vol. V [l]	
Height H [mm]	140	0.8	1.14	1.48	1.82	2.18		0.74
	120	1.36	1.86	2.37	2.89	3.4		0.66
	100	1.82	2.45	3.09	3.73	4.38		0.54
	80	2.29	3.06	3.84	4.62	5.41	0.4	



Service instructions
M6: max. 5 Nm
G3/8: max. 15 Nm

Measuring procedure: Room temperature / Force-height-data quasistatic / Dynamic data at 1 Hz